



NOTES

When running general-purpose motors

- **Driving a 400V general-purpose motor**
When driving a 400V general-purpose motor with an inverter using extremely long cables, damage to the insulation of the motor may occur. Use an output circuit filter (OFL) if necessary after checking with the motor manufacturer. Fuji's motors do not require the use of output circuit filters because of their reinforced insulation.
- **Torque characteristics and temperature rise**
When the inverter is used to run a general-purpose motor, the temperature of the motor becomes higher than when it is operated using a commercial power supply. In the low-speed range, the cooling effect will be weakened, so decrease the output torque of the motor. If constant torque is required in the low-speed range, use a Fuji inverter motor or a motor equipped with an externally powered ventilating fan.
- **Vibration**
When the motor is mounted to a machine, resonance may be caused by the natural frequencies, including that of the machine. Operation of a 2-pole motor at 60Hz or more may cause abnormal vibration.
* Study use of tier coupling or dampening rubber.
* It is also recommended to use the inverter jump frequency control to avoid resonance points.
- **Noise**
When an inverter is used with a general-purpose motor, the motor noise level is higher than that with a commercial power supply. To reduce noise, raise carrier frequency of the inverter. High-speed operation at 60Hz or more can also result in more noise.

When running special motors

- **Explosion-proof motors**
When driving an explosion-proof motor with an inverter, use a combination of a motor and an inverter that has been approved in advance.
- **Brake motors**
For motors equipped with parallel-connected brakes, their braking power must be supplied from the primary circuit (commercial power supply). If the brake power is connected to the inverter power output circuit (secondary circuit) by mistake, problems may occur.
Do not use inverters for driving motors equipped with series-connected brakes.
- **Geared motors**
If the power transmission mechanism uses an oil-lubricated gearbox or speed changer/reducer, then continuous motor operation at low speed may cause poor lubrication. Avoid such operation.
- **Single-phase motors**
Single-phase motors are not suitable for inverter-driven variable speed operation. Use three-phase motors.

Environmental conditions

- **Installation location**
Use the inverter in a location with an ambient temperature range of -10 to 50°C.
The inverter and braking resistor surfaces become hot under certain operating conditions. Install the inverter on nonflammable material such as metal.
Ensure that the installation location meets the environmental conditions specified in "Environment" in inverter specifications.

Combination with peripheral devices

- **Installing a molded case circuit breaker (MCCB)**
Install a recommended molded case circuit breaker (MCCB) or an earth leakage circuit breaker (ELCB) in the primary circuit of each inverter to protect the wiring. Ensure that the circuit breaker capacity is equivalent to or lower than the recommended capacity.
- **Installing a magnetic contactor (MC) in the output (secondary) circuit**
If a magnetic contactor (MC) is mounted in the inverter's secondary circuit for switching the motor to commercial power or for any other purpose, ensure that both the inverter and the motor are fully stopped before you turn the MC on or off. Remove the surge killer integrated with the MC.
- **Installing a magnetic contactor (MC) in the input (primary) circuit**
Do not turn the magnetic contactor (MC) in the primary circuit on or off more than once an hour as an inverter fault may result. If frequent starts or stops are required during motor operation, use FWD/REV signals.
- **Protecting the motor**
The electronic thermal facility of the inverter can protect the general-purpose motor. The operation level and the motor type (general-purpose motor, inverter motor) should be set. For high-speed motors or water-cooled motors, set a small value for the thermal time constant to protect the motor.
If you connect the motor thermal relay to the motor with a long cable, a high-frequency current may flow into the wiring stray capacitance. This may cause the relay to trip at a current lower than the set value for the thermal relay. If this happens, lower the carrier frequency or use the output circuit filter (OFL).
- **Discontinuance of power-factor correcting capacitor**
Do not mount power factor correcting capacitors in the inverter (primary) circuit. (Use the DC REACTOR to improve the inverter power factor.) Do not use power factor correcting capacitors in the inverter output circuit (secondary). An overcurrent trip will occur, disabling motor operation.
- **Discontinuance of surge killer**
Do not mount surge killers in the inverter output (secondary) circuit.
- **Reducing noise**
Use of a filter and shielded wires are typical measures against noise to ensure that EMC Directives are met.

Measures against surge currents

If an overvoltage trip occurs while the inverter is stopped or operated under a light load, it is assumed that the surge current is generated by open/close of the phase-advancing capacitor in the power system.
We recommend connecting a DC REACTOR to the inverter.

Megger test

When checking the insulation resistance of the inverter, use a 500V megger and follow the instructions contained in the Instruction Manual.

Wiring

- **Wiring distance of control circuit**
When performing remote operation, use the twisted shield wire and limit the distance between the inverter and the control box to 20m.
- **Wiring length between inverter and motor**
If long wiring is used between the inverter and the motor, the inverter will overheat or trip as a result of overcurrent (high-frequency current flowing into the stray capacitance) in the wires connected to the phases. Ensure that the wiring is shorter than 50m. If this length must be exceeded, lower the carrier frequency or mount an output circuit filter (OFL).
When wiring is longer than 50m, and sensorless vector control or vector control with speed sensor is selected, execute off-line tuning.
- **Wiring size**
Select cables with a sufficient capacity by referring to the current value or recommended wire size.
- **Wiring type**
Do not use multicore cables that are normally used for connecting several inverters and motors.
- **Grounding**
Securely ground the inverter using the grounding terminal.

Selecting inverter capacity

- **Driving general-purpose motor**
Select an inverter according to the applicable motor ratings listed in the standard specifications table for the inverter. When high starting torque is required or quick acceleration or deceleration is required, select an inverter with a capacity one size greater than the standard.
- **Driving special motors**
Select an inverter that meets the following condition:
Inverter rated current > Motor rated current.

Transportation and storage

When transporting or storing inverters, follow the procedures and select locations that meet the environmental conditions that agree with the inverter specifications.

FRENIC-HVAC

Smile to the Environment

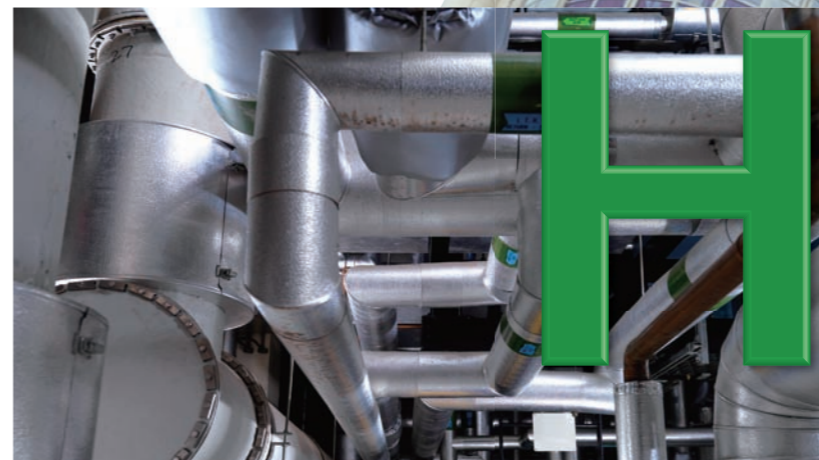

VAC

High performance enabled by the comprehensive use of Fuji technology.
Easy maintenance for the end-user. Maintains safety and protects the environment. Opens up possibilities for the new generation.



Fuji Electric Co., Ltd.

Gate City Ohsaki, East Tower, 11-2,
Osaki 1-chome, Shinagawa-ku,
Tokyo 141-0032, Japan
Phone: +81-3-5435-7057 Fax: +81-3-5435-7420
URL: <http://www.fujielectric.com/>

Smile to the Environment FRENIC-HVAC

~ Energy Saving for the environment and our children's future ~

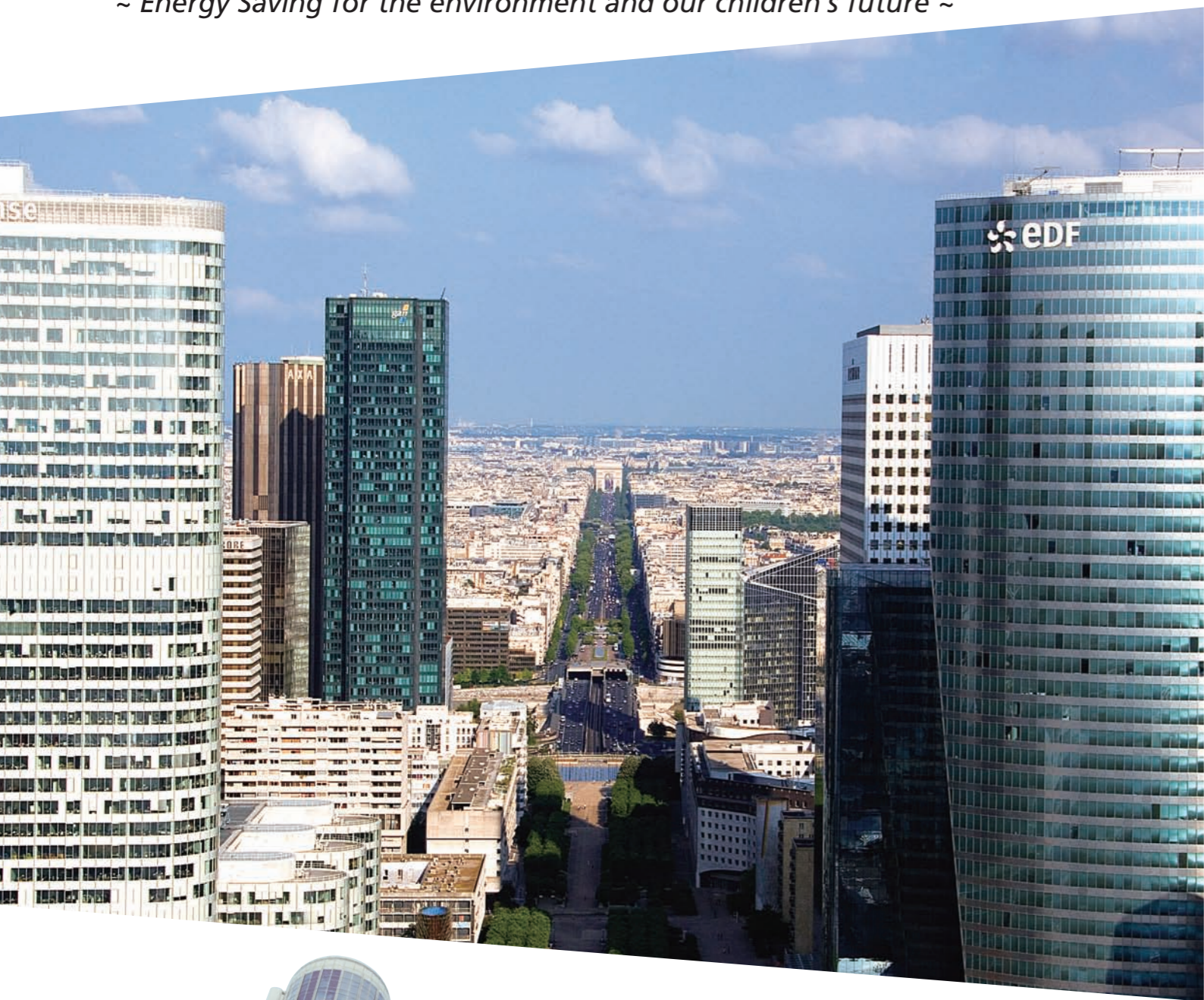

Large Contribution to Reducing Global Warming (Environmental Protection) with Energy Saving

50% of energy consumption in office buildings is related to air conditioning. The FRENIC HVAC series is the dedicated inverter for HVAC that features functions and performances offer the optimal thermal environment for the people working in the building by keeping the energy consumption in various devices (compressor, condenser water pump, AHU and others) to the minimum. Fuji Electric contributes largely to global environment by realizing carbon dioxide reduction with energy saving by the inverter.

Wide variation in model capacity

Model can be selected from two model types.

Standard type (EMC filter built-in type)

0.75 to 710kW (Protective structure IP21 or IP55 can be selected with the model between 0.75 and 90kW.)

DCR built-in + EMC filter built-in type

0.75 to 90kW (Protective structure IP21 or IP55 can be selected with the model between 0.75 and 90kW.)

Inverter capacity	EMC filter	DC reactor	Protective structure
0.75kW to 90kW	Built-in	Built-in	IP21/IP55
110kW to 710kW	Built-in	External	IP00

* The models with inverter capacity 45kW to 710kW are coming soon.

Optimal control with energy-saving function

- Linearization function
- Temperature difference constant control and pressure difference constant control
- Energy saving functions including wet-bulb temperature presumption control
- Automatic energy-saving operation

Slim body

The first slim body design among the Fuji Electric inverters. The size is the same between IP21 and IP55 (the first in the industry).

Functions suitable for HVAC use

- 4PID control
- Fire mode (forced operation)
- Pick-up operation function
- Real time clock
- Torque vector control
- Filter clogging prevention function
- Customized logic
- User friendly, useful keypad
- Password function



The first slim-type inverter specialized in energy-saving from Fuji Electric. Achieves a great effect on energy-saving of fans and pumps! Contributes drastically to cost reduction by cutting power consumption!

The energy consumed in fans and pumps for HVAC operation can be significantly saved by using inverters. To achieve this purpose, the market demands higher functionality and performance to inverters. The FRENIC-HVAC series, Fuji Electric's new product, controls water and air flow rates, pressure, and temperature with the fan and pump optimally, contributing a lot to saving electricity and cost reduction achieved by energy saving.

Significant Energy Saving Realized!!

For an air-conditioning heat source system, the needed quantity of the cooling or heating water fluctuates generally in seasons or days and nights. Therefore, operations continuing in a water conveyance pressure constant control may lead to high operating unnecessary pressures on terminals at low operating state. Thus, the pump consumes an ineffectual electric power for maintaining the high water conveyance pressure.

FRENIC-HVAC can perform an estimated terminal pressure control by linearization function which estimates target pressure from load flow rate.

It is possible to reduce the ineffectual pump power consumption and to achieve a great energy-saving effect together with maintaining comfortable current air conditioning.

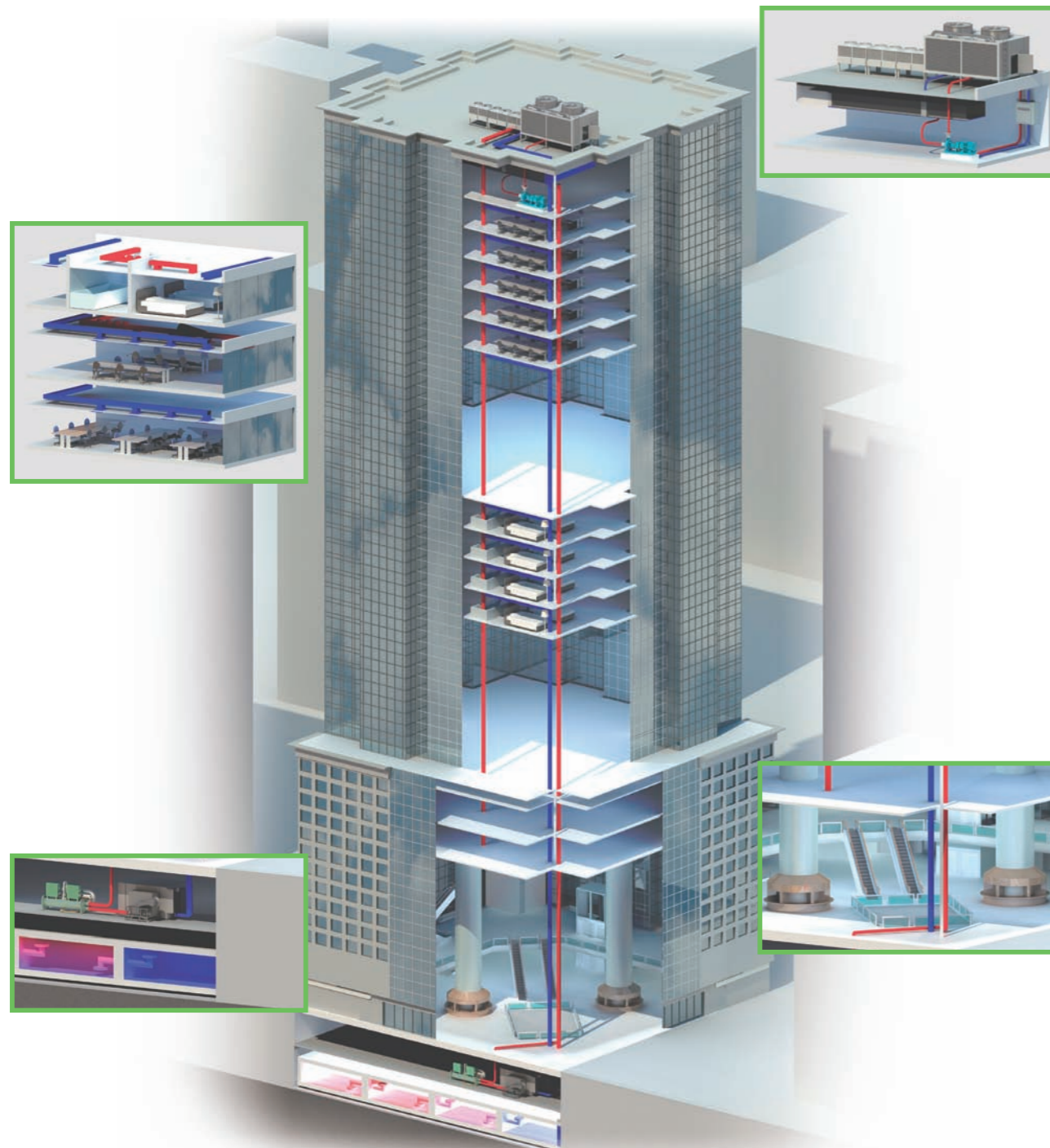

Optimum Control for HVAC Facilities

• Cooling tower fan

The cooling tower fan is used to cool the heat of cooling water by emitting it into the air. The fan speed is adjusted optimally according to the cooling water temperature at the outlet. Moreover, the inverter estimates the wet-bulb temperature automatically to control the fan so that the temperature of cooling water (wet bulb) is interlocked to the air temperature. (Wet-bulb temperature presumption control)



• Cooling water pump

The cooling water pump circulates the cooling water to the cooling tower in order to cool the heat generated by the freezing machine. The pump speed is adjusted optimally according to the temperature and flow rate of cooling water. Moreover, the inverter can control the cooling pump so that the difference of cooling water temperature at between the inlet and outlet becomes always constant. (Temperature difference constant control)



• Chilled water pump

The chilled water pump circulates the chilled water generated with the freezing machine to the air conditioner and fan coil. The pump speed is adjusted optimally according to the header pressure. Moreover, the pump conveyance pressure can be controlled to proper value by converting the flow rate signal to the target pressure using the linearization function. (Linearization function)



• Supply fan / Return fan

The speed of supply and return fans is adjusted optimally according to the pressure, discharge temperature, room temperature, and others. Moreover, the highest level of carbon dioxide is selected automatically by detecting the level in room to control it to stay within the allowable level.

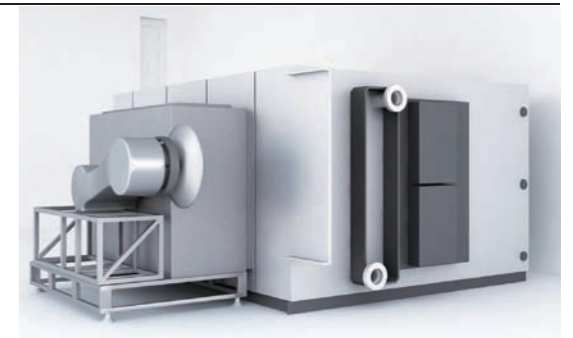

Optimal Structure Design

User friendly, easy to see keypad

- The regulator is indicated by enlarging the LCD.

- | | | |
|----------------------------|-------------------|-----------------------|
| 1. Present value (PV) | 5. Output current | 9. Power consumption |
| 2. Setting value (SV) | 6. Output voltage | 10. Cumulative energy |
| 3. Manipulating value (MV) | 7. Torque | |
| 4. Frequency | 8. Rotation speed | |



*Possible to show understandable indications through the unit conversion function.
*Multi-language function: 19 languages + user customized language supported

- Multi-language supported: 19 languages + user customized language

Language				
Japanese	English	(Chinese)	German	French
Spanish	Italian	(Russian)	(Greek)	(Turkish)
(Malay)	(Vietnamese)	(Thai)	(Indonesian)	(Polish)
(Czech)	(Swedish)	(Portuguese)	(Dutch)	

* Languages in parentheses are soon to be supported.

Real time clock (RTC) is provided as standard.

- Alarm information with date and time

- Alarm information for last ten times is stored and displayed with date and time.

Easy failure analysis

- Timer function

- Possible to set the maximum four timers for a week.
- Possible to set flag holidays (20 days a year).

Operation schedule can be set according to actual condition by using four timers.

Example When operation is performed in the same schedule through a week

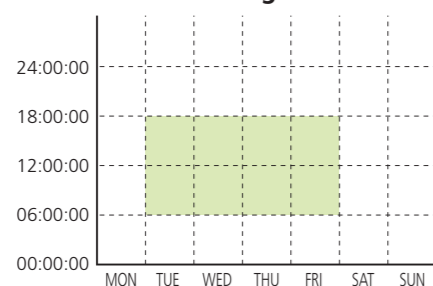

When operation schedule varies depending on the day of the week

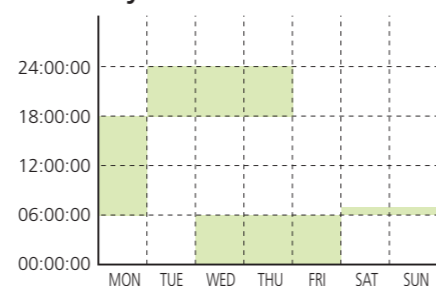

- Unit conversion function between PV and SV values

- Unit conversion allows you to easily set data.

Function	Units			
	Unit conversion	No conversion	%	RPM
	m ³ /h	°C	mbar	bar
	kPa	mWG	mmHg	kW
	in-wg	psi	°F	ppm
	PSI			

- 1 User-friendly, easy to see dedicated keypad

Multi-language supported, HELP function featured, unit setting with SV and PV values, data copy (three kinds), detachable and can be attached on the panel (using an optional cable)

- 5 Cooling fan

Easy replacement just by simply removing and attaching the part. Life prolongation is possible by controlling ON and OFF.

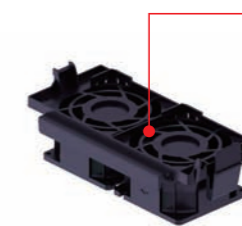

- 4 Capacitor board

Outputs the life prediction signal determining capacitor capacity drop and cumulative running hours. This allows the user to grasp replacement period.



- 6 EMC filter

Drastically reduces noise. Provided to units of all capacities. Conforming to IEC61800-3.

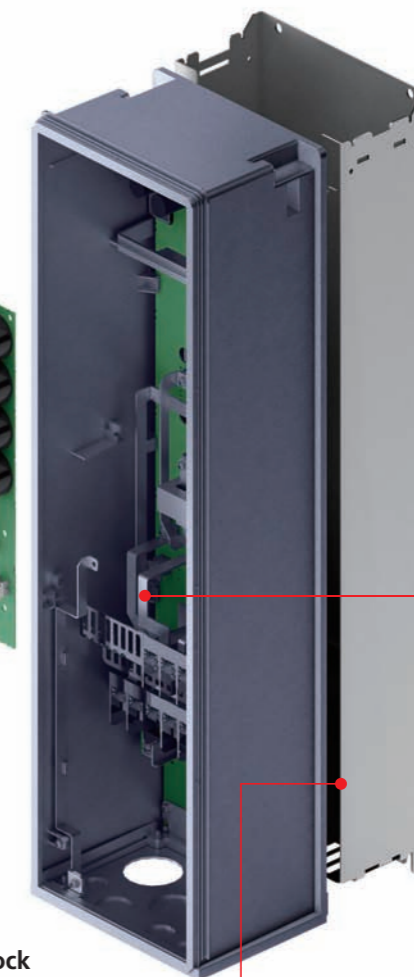

- 3 Control terminal block

The detachable control terminal block is adopted. This allows the unit to be replaced easily without disconnecting cables.

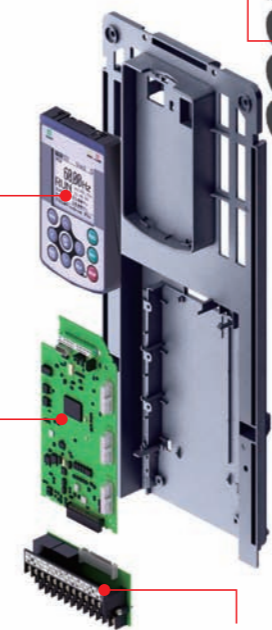

- 2 Control board

USB port equipped, BACnet equipped as standard. Max. three types of built-in optional boards can be mounted all together. Optional battery connection. Various communications options

Standard equipment	Optional equipment
• BACnet MS/TP	• LonWorks • DeviceNet
• Modbus RTU	• Ethernet • CANopen
• Metasys N2	• Profi bus • CC-Link

- 7 DCR

Drastically reduces harmonic noise. Conforming to IEC/EN61000-3-2 and IEC/EN61000-3-12. Provided as standard (to models up to 90kW), and can be attached externally as an option (to models from 110kW to 710kW).

- 8 Environmental immunity

3C2, IEC60721-3-3 supported

- 9 Others

Support/analysis software by loader, RTC backup by battery (option)

Functions Suitable for HVAC Use

Linearization function

This function estimates the target pressure using the load flow rate, which allows the estimated terminal pressure to be controlled.

For an air-conditioning heat source system, the needed quantity of the cooling or heating water fluctuates generally in seasons or days and nights. Therefore, operations continuing in a water conveyance pressure constant control may lead to high operating unnecessary pressures on terminals at low operating state. Thus, the pump consumes an ineffectual electric power for maintaining the high water conveyance pressure.

Based on the calculated value and water conveyance pressure of estimated terminal pressure using the detected load flow rate, PID control is performed.

It is possible to reduce the ineffectual pump power consumption and to achieve a great energy-saving effect together with maintaining comfortable current air conditioning.

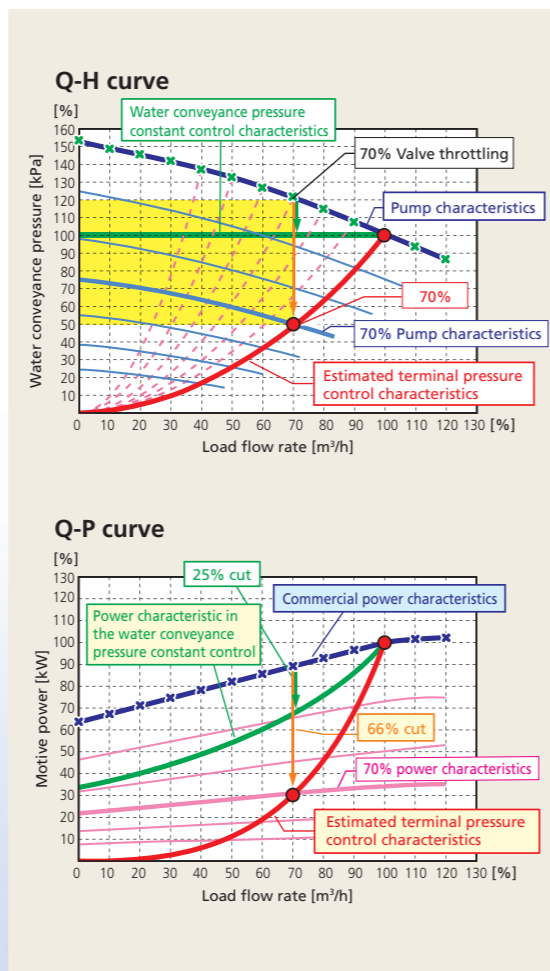
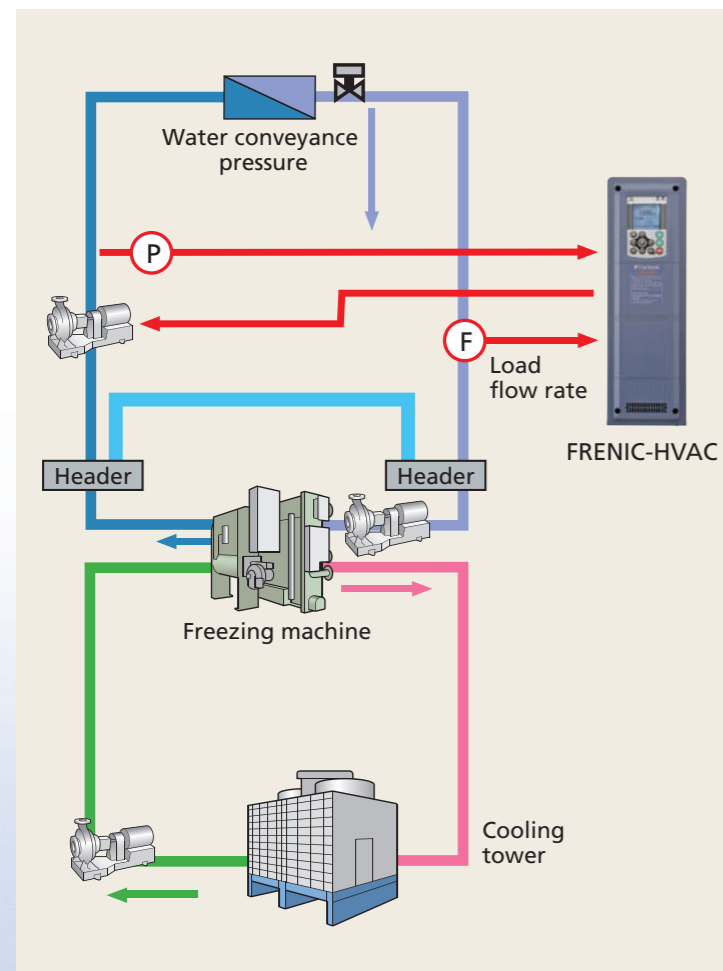

Wet-bulb temperature presumption control

This function is optimal for controlling the fan of cooling tower. Since the wet-bulb temperature would become higher than the set temperature when the air temperature is particularly high, water temperature will not reach the set temperature. Therefore, the fan keeps rotating at high speed, failing in energy-saving operation. FRENIC-HVAC automatically estimates the wet-bulb temperature and controls the fan so that the cooling water is interlocked with the air temperature in order not to use unnecessary electric power.

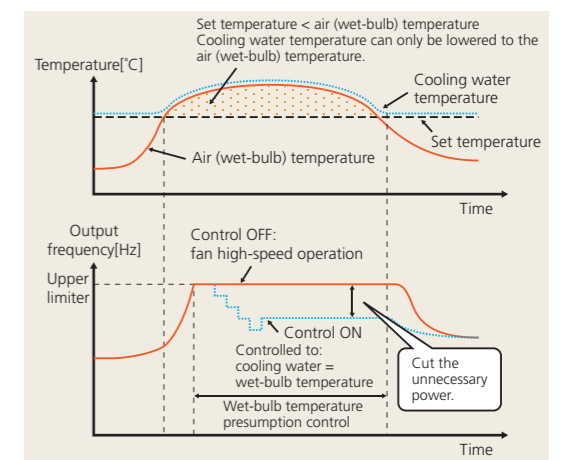

Filter clogging prevention function

This function detects clogging of the fan filter with dust or other materials using the output current and pressure sensor value. When clogging is detected, the fan is rotated in reverse to eject dust, and then resumes rotation in forward to blow air. In addition, the function notifies you of maintenance necessity with the alarm signal.

Customized logic

The customized logic interface function is provided to the inverter body. This enables forming of logic circuit and arithmetic circuit to the digital and analog input and output signals, allowing simple relay sequence to be built while processing the signals freely.

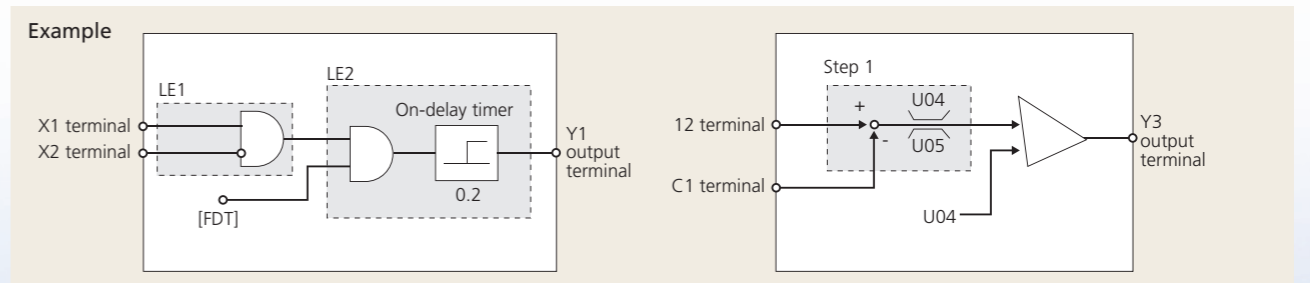

Standard 4PID control

The 4PID control is featured as standard. One PID module is used to control the output frequency of the inverter, and the other three PIDs can be used to control the external system. To utilize all of four PIDs, the optional card (OPC-G1-AIO) needs to be mounted.

Fire mode (forced operation)

This mode ignores (retry) the inverter protection function to continue the operation. In that way, the inverter keeps operating the fan and pump as much as possible in case of emergency such as fire.

Password

Function codes can be read/write, displayed or hidden by setting the two passwords. This prevents erroneous operation or overwriting of function codes. In addition, if a wrong password was input exceeding the specified number of times, the inverter is restricted from operating as the user is regarded as improper.

Pick-up operation function

The pick-up operation function enables smooth starts. If you wish to run a fan currently not run by the inverter and in idle mode, this function searches the speed regardless of the direction of rotation and pick up the motion smoothly. This function allows for smooth operation such as when switching the power supply from the commercial power to inverter in a momentary action.

Standard Specifications

Common Specifications

3-phase, 400V series (0.75 to 37kW)

Item		Specifications											
Model	FRN□□□ AR1 □-4A : HVAC	0.75	1.5	2.2	3.7	5.5	7.5	11	15	18.5	22	30	37
	FRN□□□ AR1 □-4E : HVAC	0.75	1.5	2.2	4.0	5.5	7.5	11	15	18.5	22	30	37
	FRN□□□ AR1 □-4C : HVAC	0.75	1.5	2.2	3.7	5.5	7.5	11	15	18.5	22	30	37
Applicable standard motor (rated output) [kW] *1		0.75	1.5	2.2	3.7/4.0	5.5	7.5	11	15	18.5	22	30	37
Output ratings	Rated capacity [kVA] *2	1.9	3.1	4.1	6.8	10	14	18	24	29	34	45	57
	Voltage [V] *3	3-phase, 380 to 480V (with AVR function)											
	Rated current [A]	2.5	4.1	5.5	9.0	13.5	18.5	24.5	32	39	45	60	75
	Overload current rating	110%-1min(Overload tolerated interval: compliant with IEC 61800-2)											
	Rated frequency [Hz]	50, 60Hz											
Input Power Supply	Main power supply (No. of phase, voltage, frequency)	3-phase, 380 to 480V, 50/60Hz											
	Control power supply auxiliary-input (No. of phase, voltage, frequency)	Single phase, 380 to 480V, 50/60Hz											
	Fan power supply auxiliary-input (No. of phase, voltage, frequency) *4	—											
	Voltage, frequency variations	Voltage: +10 to -15%(Unbalance rate between phases is within 2%) *5 Frequency: +5 to -5%											
	Rated input current [A] *6	1.6	3.0	4.3	7.4	10.3	13.9	20.7	27.9	34.5	41.1	55.7	69.4
Required power supply capacity [kVA]	1.2	2.1	3.0	5.2	7.2	9.7	15	20	24	29	39	49	
Braking	Braking torque [%]*7	20											
	DC braking	Braking starting frequency: 0.0 to 60.0Hz, Braking time: 0.0 to 30.0s, Braking level: 0 to 60%											
EMC filter (IEC/EN61800-3:2004)		Compliant with EMC standard Emission Immunity: Category-C2 (2nd Env.)											
DC reactor (DCR)		Standard accessory (IEC/EN61000-3-2 IEC/EN61000-3-12)											
Power factor(at rated load)	Fundamental wave PF	> 0.98											
	Total PF	≥ 0.90											
Compliant with safety standard with		UL508C, C22.2No.14, IEC/EN61800-5-1:2007											
Enclosure(IEC/EN60529)		IP21/IP55											
Cooling method		Natural cooling						Fan cooling					
Weight/Mass [kg]	IP21/IP55	10	10	10	10	10	10	18	18	18	18	23	23

Models with capacity range from 45kW to 710kW are to be released soon.

- *1) Applicable standard motors are the case of Fuji Electric's 4-pole standard motors.
- *2) The rated capacity indicates the case of 440V ratings
- *3) Output voltage cannot exceed the power supply voltage.
- *4) Used as the AC fan power supply input when combined with a high power factor PWM converter with power regenerative function or similar unit.
- *5) Interphase voltage unbalance ratio [%] = (max. voltage [V] - min. voltage [V]) / 3-phase average voltage [V] x 67 (See IEC61800-3.)
Use the AC reactor(ACR: optional) when used with 2 to 3%, of unbalance ratio.
- *6) USB port equipped, three types of optional board can be mounted!!
- *7) Average braking torque obtained by use of a motor.(Varies with the efficiency of the motor)

Item		Detail specifications		Remarks
Output frequency	Maximum frequency	25 to 120Hz (by vector control w/ PG)		
	Base frequency	25 to 120Hz		
	Starting frequency	0.1 to 60.0Hz		
	Carrier frequency	0.75 to 16kHz (0.75kW to 37kW) Note: Carrier frequency may drop automatically according to ambient temperature and output current to protect the inverter. (This automatic lowering function can be cancelled.)		
	Output frequency accuracy	<ul style="list-style-type: none"> Analog setting : Less than ±0.2% of maximum frequency (at 25±10°C) Keypad setting : Less than ±0.01% of maximum frequency (at -10 to +50°C) 		
Setting resolution	<ul style="list-style-type: none"> Analog setting : 1/3000 of maximum frequency (1/1500 w/ [V2] input) Keypad setting : 0.01Hz (99.99Hz or less), 0.1Hz (100.0 to 120Hz) Link setting : 1/20000 of maximum output frequency or 0.01Hz (fixed)* 			
Control method	<ul style="list-style-type: none"> V/f control Dynamic torque vector control V/f control, slip compensation provided* 			
Voltage/freq. characteristic	<ul style="list-style-type: none"> Possible to set 160 to 500V at base frequency and at maximum output frequency (common spec). VR control can be turned ON or OFF. Polygonal line setting (3 points): An arbitrary voltage (0 to 500V) and frequency (0 to 120Hz) can be set. 			
Torque boost	<ul style="list-style-type: none"> Automatic torque boost Manual torque boost: An arbitrary torque boost value (0.0 to 20.%) can be set. Applied load can be set (for constant torque load, variable torque load)* 			
Starting torque	<ul style="list-style-type: none"> 100% or more/set frequency: 1.0Hz W/ base frequency 50Hz and w/ slip compensation and automatic torque boost* 			
Start/stop operation	Keypad operation	Start and stop with / and keys.		
	External signals (Digital inputs)	:Forward (reverse) rotation, stop command(capable of 3-wire operation), coast-to-stop command, external alarm, alarm reset, etc.		
	Link operation	:Operation through RS485 communication and Field Bus communication (option)		
Control	Operation command switching	:Remote/local switch, link switch, second operation command switch		
	Keypad operation	: Can be set with , keys		+1 to +5V DC: Adjustable with the bias/analog input gain.
	External potentiometer	: Can be set with the external variable resistor (1 to 5kΩ, 1/2W)		
	Analog input	: 0 to ±10V DC (±5V DC)/0 to ±100% (terminals [12] and [V2]) 0 to +10V DC/0 to +100% (terminals [12] and [V2]) : 4 to 20mA DC/0 to 100% (terminal [C1]) 4 to 20mA DC/0 to 100% (terminal [C1])		
	UP/DOWN operation	: The frequency rises or lowers while the digital input signal is turned on.		
	Multistep frequency	: Selectable from 16 steps (step 0 to 15)		
	Link operation	: Can be set with RS485 communications.		
	Frequency setting change	: Two types of frequency settings can be switched by using the external signal (digital input). Switching between remote/local, or link switching.		
	Auxiliary frequency setting	: Input at terminals [12], [C1], or [V2] can be selected as an additional input to the main setting.		
	Inverse operation	: 0 to +10V DC/0 to 100% can be switched to +10 to 0 V DC/0 to 100% with external operation. : 4 to 20mA DC/0 to 100% can be switched to 20 to 4mA DC/0 to 100% with external operation. : 0 to 20mA DC/0 to 100% can be switched to 20 to 0mA DC/0 to 100% with external operation.		
Pattern operation	: Can be set up to 7 steps.			
Acceleration/ deceleration time	Setting range	: Set the time between 0.00 and 6000s.		
	Selection	: 4 types of acceleration and deceleration can be set and selected individually (can be switched during operation).		
	Acceleration/deceleration pattern	: Linear, S-curve (weak or strong), non-linear (constant output max. capacity)		
Deceleration mode (coast-to-stop)	: The motor coasts to stop with operation command OFF			
Deceleration time for forced stop	: The motor is decelerated to stop in dedicated deceleration time by pressing the forced stop key.			
Frequency limiter (Higher and lower limiter)	<ul style="list-style-type: none"> Higher and lower limiters can be variably-set with an Hz value. When a set value is lower than the lower limiter, operation can be set either to be continued at the lower limiter frequency or to be stopped. 			
Bias frequency	: Bias of set frequency and PID command can be set individually in the range between 0 and ±100%.			
Analog input	<ul style="list-style-type: none"> Gain : Set between 0 and 200%. Offset: Set between -5.0% and +5.0%. Filter : Set between 0.00s and 5.00s. 			
Jump frequency setting	<ul style="list-style-type: none"> Three operation points and the common jump width (0 to 30Hz) can be set. It is possible to detect the resonance point automatically to set the jump frequency automatically. 			
Restart after momentary power failure	<ul style="list-style-type: none"> Trip upon power failure: Trip the motor immediately with power failure. Trip upon power recovery: Put the motor in coast-to-run mode with power failure and then trip the motor after power recovery. Operation continuation: Operation is continued using the load inertia energy. Start with frequency before momentary power failure: Put the motor in coast-to-run mode with power failure and start the motor with the frequency before momentary power failure occurs after power recovery. Start with start frequency: Put the motor in coast-to-run mode with power failure and start the motor with the start frequency after power recovery. 			
Current limit (Hardware current limit)	: Current limit by the hardware is performed in order to prevent sharp load change with which the software current limit cannot respond or trip on excessive current due to momentary power failure. (This can be cancelled.)			
Line/inverter switching	<ul style="list-style-type: none"> 50/60Hz output with line selection command.(SW50, SW60) Line selection sequence is built in. 			

Common Specifications

Item	Detail specifications	Remarks
Slip compensation	• Compensates the speed change according to the load.	
Torque limit	• Switching to 1st torque limit value or 2nd torque limit value	
Current limit (Software current limit)	• Frequency is automatically lowered so that it becomes less than the operation level set with the output current.	
PID control	• PID regulator for process control • Normal operation/reverse operation selection • Slow flowrate function (Pressurized operation is possible before this function) • Automatic frequency updating function for slow flowrate stop • PID command: keypad, analog input (terminals [12], [C1], [V2]), RS-485 communications • PID feedback value: analog input (terminals [12], [C1], [V2]) • Alarm output (absolute/deviation) • PID feedback abnormality detection • Sensor input amount scaling • Sensor input amount conversion/calculation • PID limiter • Integration reset/hold • Anti-reset wind-up function • PID auto tuning	
Pick-up	• Motor rotation speed is estimated before startup and so operation begins to start a running motor in idle mode without stopping. (Motor electric constant needs to be tuned: off-line tuning)	
Automatic deceleration	• If the DC link voltage/torque calculation value exceeds the regenerated current avoidance level at deceleration, the deceleration time is automatically extended to avoid over voltage trip. (Speed can be forcibly decelerated when the deceleration time reaches three times or more.) • If the torque calculation value exceeds the regenerated current avoidance level during constant-speed operation, trip upon overvoltage is avoided by the control with which the frequency is increased. • The regenerated current avoidance level can be set.	
Deceleration characteristics	• The motor loss increases during deceleration to reduce the load energy regenerating at the inverter to avoid an trip upon overvoltage.	
Automatic energy-saving operation	• The output voltage is controlled to minimize the total sum of the motor loss and inverter loss at a constant speed.	
Active drive	• If the ambient temperature or the temperature at IGBT connection part rises due to overload, the inverter output frequency is reduced to avoid overload.	
Operation continuance at input phase loss	• After an alarm output and then stop by trip/warning output, either operation continuance at low output or waning output only (operation is continued) can be selected.	
Off-line tuning	• Motor constant is tuned at rotation mode and non-rotation mode.	
Cooling fan ON/OFF control	• The inverter internal temperature is detected, and the cooling fan is stopped when the temperature is low. • The control signal can be output to the external unit.	
Universal DI	• The condition of external digital signal connected to the general digital input terminal is transmitted to the host controller.	
Universal DO	• The digital command signal is output from the host controller to the general digital output terminal.	
Universal AO	• The analog command signal at the host controller is output to the analog output terminal.	
Restriction on rotation direction	• CCW or CW rotation prevention	
Motor condensation prevention	• Apply current automatically when the inverter stops to raise the temperature of the motor to prevent dew condensation.	
Customized logic I/F	• 2 inputs, 1 output, logical operation, numeric operation, timer function, 14 steps	
Pump control	• Filter clogging prevention function • Anti-jam function • Wet-bulb temperature presumption control	
Fire mode (Forced operation)	• Ignores the inverter alarm and forcibly performs retry operation.	
Pattern operation	• Pattern operation can be performed by the inverter independently. 2 inputs, 1 output, logical operation, timer function, 10 steps	
Real time clock (RTC)	• RTC allows time and date, alarm information with time and date to be indicated, and operation with timer to be performed.	Time is retained using the optional battery.
Timer operation	• 4 timers can be used for operation in a week.	
Password function	• This prevents overwriting of function codes by erroneous operation, and can hide the data (by setting 2 levels).	
Running/stopping	• Speed monitor (set frequency, output frequency, motor speed, load rotation speed, % display speed), output current [A], output voltage [V], torque calculation value [%], consumption power [kW], PID reference value, PID feedback value, Pad output, load factor [%], motor output [kW], analog input monitor, cumulative watt hours [kWh]/[MWh], phase effective value [A]	
Life early warning	• Main circuit capacitor, electrolytic capacitor on board, life warning of cooling fan • Life early warning can be output to the external unit. • Ambient temperature: IP00/IP21:40°C, IP55:30°C, load factor: inverter rated current 100%	
Cumulative run hours	• Cumulative inverter running hours, cumulative watt hours, cumulative motor running hours are displayed for the number of started times. • Prediction notice is output when the maintenance hours set beforehand and number of startup times are exceeded.	
Light alarm occurrence	• Lights up WARN and LED and display the light alarm cause.	
Trip mode	• Displays the cause of trip.	
Running or trip mode	• Trip history: Saves and displays the last 10 trip codes and the causes. • Detail of data at trip: Saves and displays the last 4 trips. • When operated using RTC, time and date of trip are saved and displayed.	
Remaining battery indication	• Battery remaining amount can be displayed when the battery (option) is connected.	
Backlight	• Backlight illumination time can be set: key operation only or always off.	
Overcurrent protection	• The inverter is stopped upon an overcurrent caused by an overload.	
Short-circuit protection	• The inverter is stopped upon an overcurrent caused by a short-circuit in the output circuit.	OC1,OC2,OC3
Grounding fault protection	• The inverter is stopped upon an overcurrent caused by a grounding fault in the output circuit.(Models with 37kW or less)	
Overvoltage protection	• Stops the inverter by detecting the DC link circuit voltage excessive value (800 V DC). However, protection will not be functioned if a strikingly excessive input voltage is applied.	OU1,OU2,OU3
Undervoltage	• Stops the inverter by detecting the DC link circuit voltage drop (400 V DC). However, no alarm is output if restart after momentary power failure is set.	LU
Input phase loss	• Stops or protects the inverter when phase loss with input voltage occurs. • Phase loss may not be detected when the load to be connected is minor.	Lin
Output phase loss	• Stops the inverter by detecting phase loss of output wiring during operation.	OPL

Item	Detail specifications	Remarks
Overheating	• Stops the inverter by detecting temperature of inverter cooling fin when any cooling fin failure or overload occurs. • Stops the inverter by detecting inverter internal temperature when any cooling fin failure or overload occurs. • Stops the inverter by detecting the cooling fin failure itself. • Stops the inverter by detecting the abnormality of charging circuit.	OH1 OH3
Overload	• The inverter is stopped upon the temperature of the heat sink of the inverter or the temperature of the switching element calculated from the output current.	OLU
External alarm input	• Stops the inverter with alarm by digital input (THR).	OH2
Motor protection		
Electronic thermal	• Stops the inverter with the electronic thermal function to protect the motor. Protects the general motor and inverter motor in all frequency ranges.(Operation level and thermal time constant (0.5 to 75.0 min) can be set.)	OL1
PTC thermistor	• Stops the inverter by detecting the motor temperature with the PTC thermistor to protect the motor. The PTC thermistor is connected between the terminals [C1] and [11] and switches on control board and function codes are set accordingly.	OH4
Overload early warning	• An overload early warning (OL) is output at the level set in advance before stopping the inverter with the electronic thermal.	—
Memory error	• Data are checked when the power is supplied and data are written, and the function stops the inverter if any memory abnormality is detected.	Er1
Keypad communications error	• When the keypad operation instruction mode is active, the function stops the inverter if any error is detected in communications between the keypad and the inverter body.	Er2
CPU error	• Stops the inverter by detecting abnormality with CPU and LSI caused by noise or other factors.	Er3
Optional communications error	• Stops the inverter by detecting abnormality in communications with the inverter body when an optional card is mounted.	Er4
Error of option	• When an optional card is mounted, the inverter is stopped if any abnormality is detected with the optional card.	Er5
Operational motion error	• STOP key prior : Even when operation commands are given with the terminal block or via communications, commands are forcibly stopped by pressing the STOP key on the keypad, and Er6 is displayed after stoppage. • If any operation command has been input, operation is started suddenly when the power is supplied, alarm is released, or operation command from link mode is switched. This function forbids the operation and displays Er6.	Er6
Tuning error	• With motor constant tuning, the inverter is stopped if tuning fails or is interrupted, or any abnormality is found with the tuning result.	Er7
RS-485 communications error (port 1)	• When RS-485 at the keypad connection port is used as network, the inverter is stopped if any abnormality is detected between the port and the inverter body.	Er8
Data save error upon undervoltage	• When undervoltage protection is activated, an error is displayed if data failed in save properly.	ErF
RS-485 communications error (port 2)	• When the network is configured using RS-485 at the control terminals [DX+] and [DX-], the inverter is stopped by detecting abnormality in communications with the inverter body.	ErP
Power supply LSI error	• Stops the inverter by detecting abnormality with LSI on the power supply board caused by noise or other similar factors.	ErH
Simulation error	• Simulated alarm is output by the keypad to check the fault sequence.	Err
PID feedback disconnection detection	• Stops the inverter when the PID control feedback signal is determined to be disconnected (setting can be enabled/disabled).	PV1, PV2, EPA, EPb, EPC
Customized logic abnormality	• An alarm is output with setting error of the customized logic.	ECL
Anti-jam	• An error is displayed when failed in starting due to over current.	rLo
Filter clogging error	• An error is displayed when overload is detected during PID control.	FoL
Enable circuit error	• Stops the inverter (*3) if any circuit abnormality is detected in diagnosis for enable circuit condition (*1, *2).	ECF
Alarm relay output (for any fault)	• A relay signal is output when the inverter is stopped with an alarm. • The alarm stop status can be cancelled by the STOP key or the digital input signal (RST).	
Light alarm (warning)	• If alarm or warning item registered as light alarm or warning occurs, the light alarm or warning is displayed. (Operation is continued.) Items to be registered: External alarm (OH2), Inverter internal overheat (OH3), motor overheat (OH4), motor overload (OL1), keypad communications error (Er2), Option communications error (Er4), Error of option (Er5), RS-485 communications error (port 1) (Er8), RS-485 communications error (port 2) (ErP), DC fan lock detection, overload prediction (for motor), cooling fin overheat prediction, Early life warning (main circuit capacitor capacity, electronic capacitor on board, or cooling fin), Command loss, PID warning output, Low torque detection, Thermistor detection (PTC), Machine life (motor cumulative running hour error), Machine life (number of starting times error)	
Stall prevention	• The output frequency decreases upon an output current exceeding the limit during acceleration or constant speed operation, to avoid overcurrent trip.	
Retry function	• When the motor is tripped and stopped, this function automatically resets the tripping state and restarts operation. (Number of retries, queuing time for retry, trip to be reset, and allowable retry time can be set.) It is possible to know how many times retry has been attempted so far using the communications.	
Surge protection	• Protect the inverter against surge voltage intruding across the main circuit power cable and ground.	
Command loss detection	• A loss (broken wire, etc.) of the frequency command is detected to output an alarm and continue operation at the preset frequency (set at a ratio to the frequency before detection)	
Momentary power failure protection	• When restart upon momentary power failure is selected, the inverter restarts upon recovery of the voltage within the set time.	
Installation location	• Shall be free from corrosive gas, flammable gas, oil mist, and dusts. Indoor use only. [Pollution degree 2 (IEC60664-1)]. Avoid direct sunlight.	
Ambient temperature	• IP00/IP21: -10 to +50°C (+50 to +60°C are covered by derating.), -10 to +40°C when closely mounted side by side (37kW or less) • IP55: -10 to +40°C (+50 to +60°C are covered by derating.), -10 to +30°C when closely mounted side by side (37kW or less)	
Ambient humidity	• 5 to 95% RH (no condensation)	
Altitude	• Lower than 1000m	
Vibration	90kW or less 3mm : 2 to 9Hz 10m/s ² : 9 to 200Hz 110 to 710kW 3mm : 2 to 9Hz 2m/s ² : 9 to 55Hz 1m/s ² : 55 to 200Hz	
Storage temperature	• -25 to +70°C	
Storage humidity	• 5 to 95% RH (no condensation)	

*1 This does not ensure detection of all the circuit failures. (Conforming to EN ISO13849-1 Cat.3)
*2 When the input of either EN1 or EN2 only is OFF, an alarm (ECF) occurs. (Regarded as disagreement when exceeding 50ms.) This alarm with this cause can be reset only by power restart.
*3 Use this in a connection manner in which output is shut off with the enable command turned to off, by feeding back the transistor output of the inverter to which the DECF signal is allocated to the reset input such as safety switch of the host unit, as needed basis.

How to read the model number

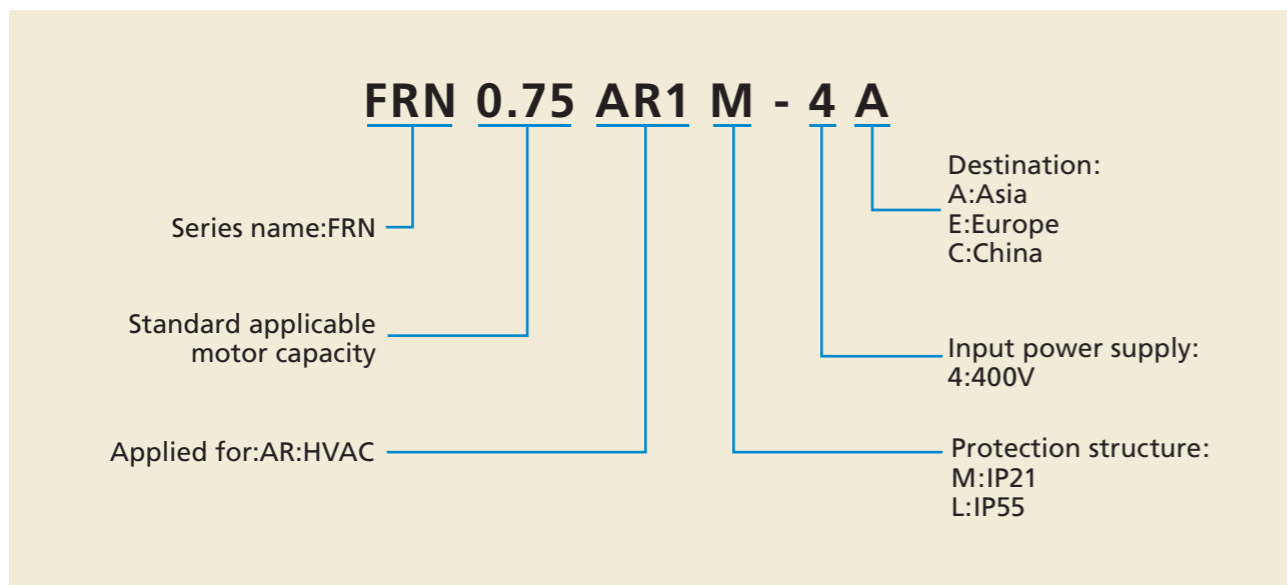

Model variation

3-phase 400V

Type	Frame size	Standard applicable motor capacity (kW)	Rated current (A)	IP21/55	DCR	EMC filter
FRN0.75AR1 □-4#	1	0.75	2.5	Standard feature	Built-in	Built-in
FRN1.5AR1 □-4#		1.5	4.1			
FRN2.2AR1 □-4#		2.2	5.5			
FRN3.7AR1 □-4#	2	3.7	9.0			
FRN5.5AR1 □-4#		5.5	13.5			
FRN7.5AR1 □-4#		7.5	18.5			
FRN11AR1 □-4#	3	11	24.5			
FRN15AR1 □-4#		15	32			
FRN18.5AR1 □-4#		18.5	39			
FRN22AR1 □-4#	4	22	45			
FRN30AR1 □-4#		30	60			
FRN37AR1 □-4#		37	75			

The models from 45kW to 710kW are coming soon.

□(Protective structure) : M : IP21, L : IP55 # (Destination) : A : Asia, E : Europe, C : China

Outline drawing

Power supply voltage	Applicable standard motor (kW)	Inverter model	Outside dimensions (mm)					Mounting dimensions (mm)					
			Dwg.no.	W	H	D	D1	D2	Dwg.no.	W1	W2	H1	H2
3-phase 400V	0.75	FRN0.75AR1 □-4#	A	150	465	262	162	100	B	115	17.5	451	7
	1.5	FRN1.5AR1 □-4#											
	2.2	FRN2.2AR1 □-4#											
	3.7	FRN3.7AR1 □-4#											
	5.5	FRN5.5AR1 □-4#											
	7.5	FRN7.5AR1 □-4#											
	11	FRN11AR1 □-4#											
	15	FRN15AR1 □-4#		203	585	262	162	100		158	22.5	571	7
	18.5	FRN18.5AR1 □-4#											
	22	FRN22AR1 □-4#											
	30	FRN30AR1 □-4#		203	645	262	162	100		158	22.5	631	7
	37	FRN37AR1 □-4#											

□(Protective structure) : M : IP21, L : IP55 # (Destination) : A : Asia, E : Europe, C : China

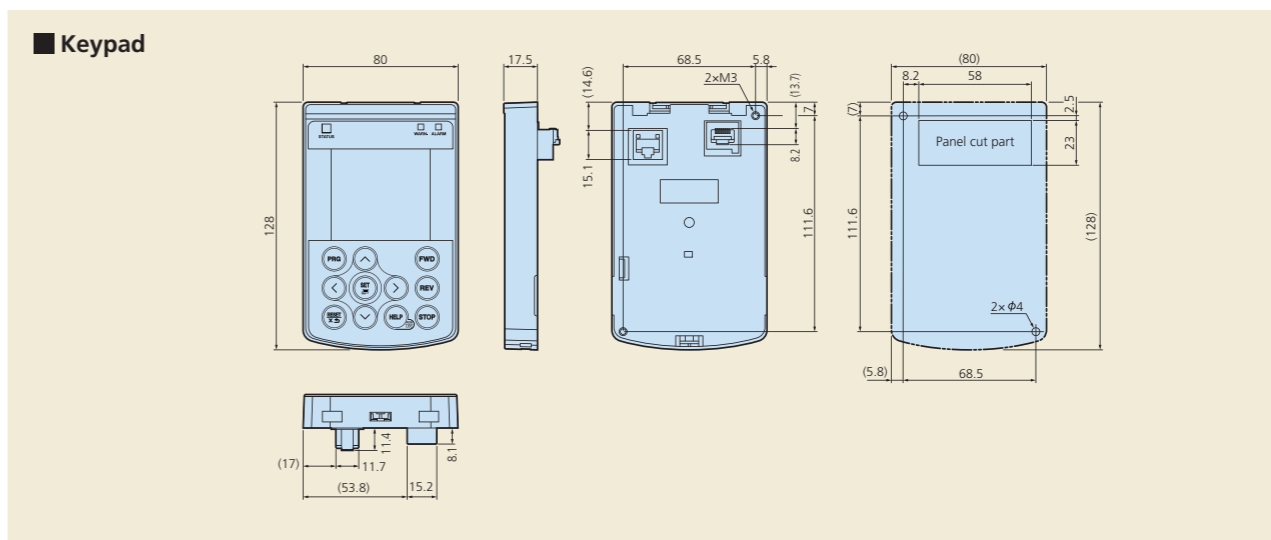
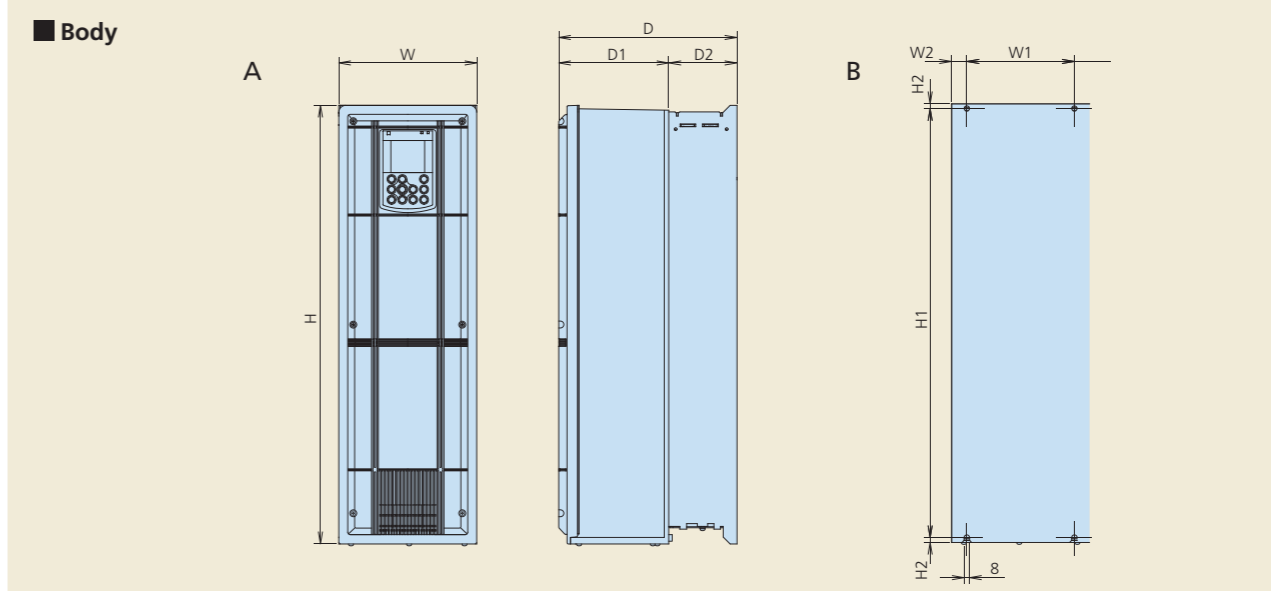

Wiring Diagram

Basic configuration diagram

(Factory shipped condition: with SINK mode input and enable input function)

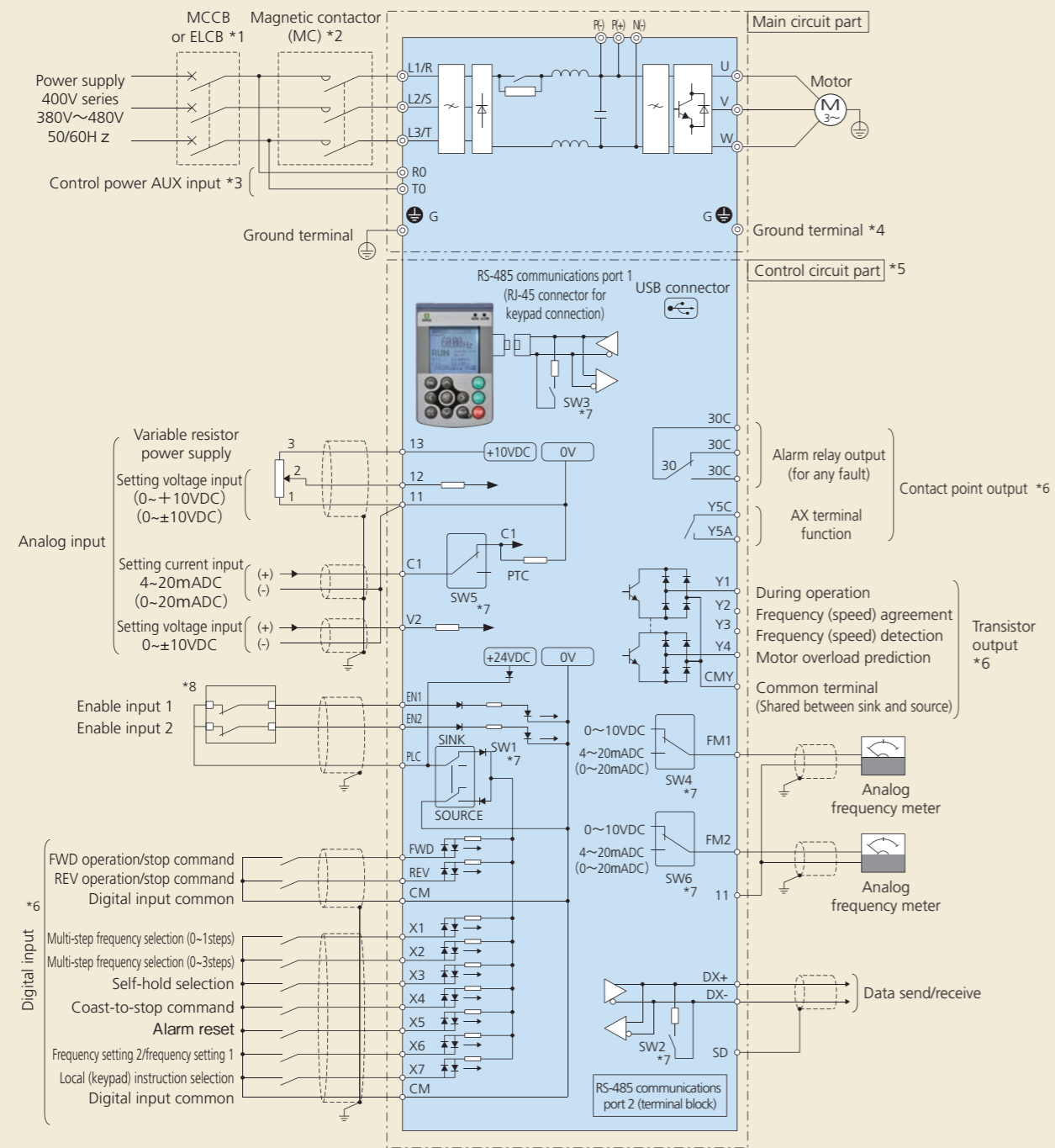

Basic configuration diagram

(Factory shipped condition: with SOURCE mode input and enable input function)

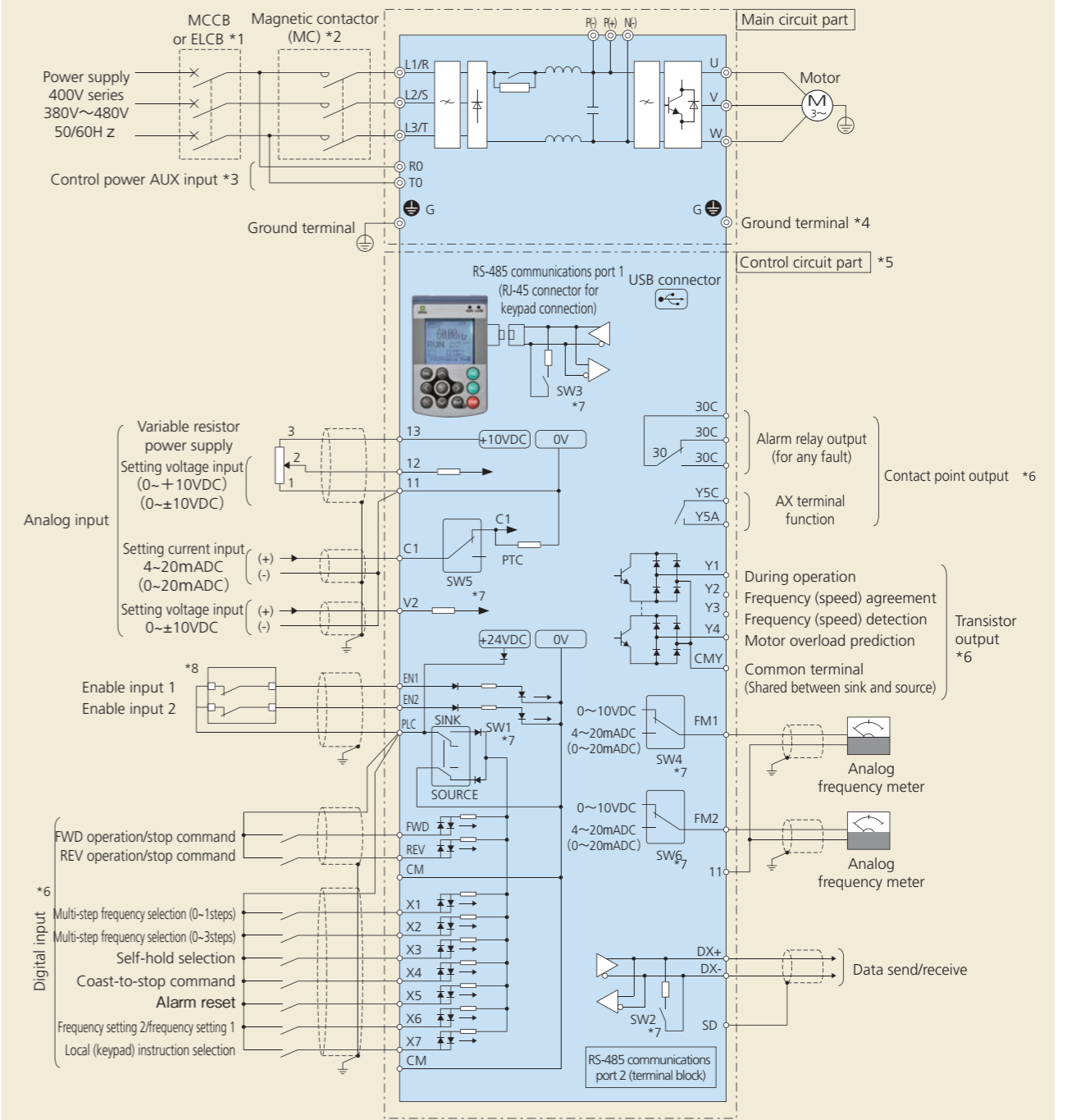

Options

Relay output interface card (OPC-G1-RY)

This is an optional card that converts the transistor output at terminals Y1 to Y4 on the inverter body to relay output (1c). Each card has two relay outputs, and four relay outputs are available by installing two cards.

Note: When the card is mounted, the terminals Y1 to Y4 on the inverter body

Relay output: 2 circuits built-in
Signal type: 1c
Contact point capacity: AC250V, 0.3A $\cos\phi=0$.
 DC48V, 0.5A (Resistance load)

Relay output interface card (OPC-G1-RY2)

This optional card allows relay outputs (1a) to be added. When used in cascaded control, this card can control the seven motors.

* By using the two relay outputs on the inverter body, max. 8 units and one unit (auxiliary pump) can be controlled.

Relay output: 7 circuits built-in
Signal type: 1a
Contact point capacity: AC250V, 0.3A $\cos\phi=0$.
 DC48V, 0.5A (Resistance load)

Analog input interface card (OPC-G1-AIO)

This card allows analog input and output to be used.

Analog input: 1 analog voltage input point (0~±10V)
 1 analog current input point (4~20mA)
Analog output: 1 analog voltage output point (0~±10V)
 1 analog current output point (4~20mA)

Analog current output interface card (OPC-G1-AO)

This card allows two analog current output (4 to 20mA) points to be used. The card cannot be used together with OPC-G1-AIO.

CC-Link communications card (OPC-G1-CCL)

By connecting this card with the CC-Link master unit, the communications rate up to 10Mbps can be supported and the transmission distance is covered up to 1200 m in total.

No. of connection units: 42 units
Communications method: CC-Link Ver1.10 and Ver2.0
Communications rate: 156kbps~

DeviceNet communications card (OPC-G1-DEV)

This card enables operation instruction and frequency command to be set from the DeviceNet master, allowing operation conditions to be monitored and all the function codes to be changed and checked.

No. of connection nodes: max. 64 units (including the master unit)
MAC ID: 0~63
Insulation: 500V DC (photocoupler insulation)
Communications rate: 500kbps/250kbps/125kbps
Network consumed power: max. 80mA, 24V DC

PROFIBUS DP communications card (OPC-G1-PDP)

This card enables operation instruction and frequency command to be set from the PROFIBUS DP master, allowing operation conditions to be monitored and all the function codes to be changed and checked.

Communications rate: 9.6kbps~12Mbps
Transmission distance: ~1,200m
Connection connector: 6-pole terminal block

CANopen communications card (OPC-G1-COP)

This card enables operation instruction and frequency command to be set from the CANopen master (such as PC and PLC), allowing all the function codes to be set and checked.

No. of connection nodes: 127 units
Communications rate: 20k, 50k, 125k, 250k, 500k, 800k, 1Mbps
Transmission distance: ~2,500m

LonWorks communications card (OPC-G1-LNW) Coming soon

This card allows peripheral equipment (including a master unit) that is connected via LonWorks to be connected with the inverter, enabling operation instruction and frequency command to be set from the master unit.

Ethernet communications card (OPC-G1-ETH) Coming soon

Pt100 temperature sensor input card (OPC-G1-PT) Coming soon

Battery (OPK-BP)

Used for the real time clock activated while the inverter power is off. The real time clock can be operated even when no power is supplied inverter at electric power interruption.

Extension cable for remote operation (CB-□S)

This cable is used in connection between the inverter body and the keypad.

Optional type	Length (m)
CB-5S	5
CB-3S	3
CB-1S	1